

Models		
1U26MADFRA	AS26PBDHRA	1U26MADFRA
1U35MADFRA	AS35PBDHRA	1U35MADFRA
1U53WADFRA	AS53PDDHRA	1U53WADFRA
1U71WADFRA	AS71PDDHRA	1U71WADFRA
1U25MAEFRA	AS90PFDHRA	1U90XADFRA
1U35MAEFRA	AS25QCEHRA	1U25MAEFRA
1U50WAEFRA	AS35QCEHRA	1U35MAEFRA
1U60KAEFRA	AS50QDEHRA	1U50WAEFRA
1U71WAEFRA	AS60QEEHRA	1U60KAEFRA
1U50WAFFRA	AS71QEEHRA	1U71WAEFRA
1U71WAFFRA	AS90QFDHRA	1U90QADFRA
1U80QAFFRA	AS25QCFHRA	1U25MAFFRA
1U90XADFRA	AS35QCFHRA	1U35MAFFRA
1U90QADFRA	AS50QDFHRA	1U50WAFFRA
	AS71QEFHRA	1U71WAFFRA
	AS80QFFHRA	1U80QAFFRA

Please read this manual carefully before installation. This appliance is filled with R32. Keep this operation manual for future reference.

0011518288



# Contents

Warning .....	1
Loading and Unloading/Transporting Management/Storage Requirements.....	2
Installation Instructions.....	3
Relocation Procedures.....	8
Maintenance Instructions.....	9
Scrapping and Recovery.....	13
Indoor/Outdoor Unit Installion Drawings.....	12
Safety Precautions .....	14
Read Before Installation .....	17
Installation Procedure.....	20
Outdoor Unit Troubleshooting.....	25



Read the precautions in this manual carefully before operating the unit.



This appliance is filled with R32.

Keep this manual where the user can easily find it.

## WARNING:

- ▲ Seek assistance from your dealer or qualified personnel for the installation of your air conditioner. Attempting to install it yourself could lead to risks such as water leakage, electric shocks, fire, or explosion.
- ▲ Install the air conditioner according to the instructions provided in the installation manual. Use only the specified accessories and parts for installation.
- ▲ Ensure the foundation can support the weight of the unit.
- ▲ Electrical work should comply with relevant local and national regulations and the instructions in the installation manual. Use a dedicated power supply circuit and appropriate wiring. The connecting wire type is H07RN-F.
- ▲ Use certified cables of suitable length and avoid using tapped wires or extension leads.
- ▲ Ensure all cables have local authentication certificates, and break off the grounding wire last during installation.
- ▲ Ventilate the area immediately if refrigerant gas leaks during installation.
- ▲ Check for refrigerant gas leakage after installation.
- ▲ Evacuate the refrigerant circuit during installation or relocation to remove air, and use only the specified refrigerant (R32).
- ▲ Ensure correct and reliable grounding. Do not earth the unit to utility pipes, lightning conductors, or telephone earth leads.
- ▲ Install an earth leakage circuit explosion-proof breaker and ensure proper disconnection means in the wiring.
- ▲ Do not use unauthorized means to accelerate defrosting or cleaning.
- ▲ Store the appliance in a room without continuously operating ignition sources, and ensure a radius of at least 2.5m around the storage area.
- ▲ Avoid piercing or burning the appliance, and be aware that refrigerants may not have an odor.
- ▲ Ensure the appliance is installed, operated, and stored in a well-ventilated room with a floor area larger than 3m.
- ▲ Comply with national gas regulations.
- ▲ This appliance is not intended for use by persons (including children) with reduced physical, sensory, or mental capabilities, unless supervised or instructed by a responsible person.
- ▲ Children should be supervised to prevent them from playing with the appliance, and cleaning and user maintenance should not be performed by children.
- ▲ Do not discard the air conditioner randomly; contact customer service if necessary.
- ▲ Connectors cannot be reused in a confined space.

---

# CAUTION:

---

- ▲ Avoid installing the air conditioner in areas prone to flammable gas leakage to prevent fire hazards.
  - ▲ Ensure proper tightening of the flare nut using specified methods like a torque wrench to prevent cracking and refrigerant leakage.
  - ▲ Take measures to prevent small animals from seeking shelter in the outdoor unit to avoid electrical malfunctions or fire risks.
  - ▲ Encourage customers to maintain cleanliness around the unit to prevent debris accumulation and potential issues.
  - ▲ Keep the inter-unit wire away from uninsulated copper pipes due to high temperatures in the refrigerant circuit.
  - ▲ Only allow qualified personnel to handle tasks such as filling, purging, and disposing of refrigerant to ensure safety and compliance.
- 

## **Loading and Unloading/Transporting Management/Storage Requirements**

---

- **Loading and Unloading Requirements**
  - 1) Handle products with care during loading and unloading to avoid damage.
  - 2) Avoid impacting indoor and outdoor units to prevent product damage.
  - 3) Read safety cautions before starting any work.
  - 4) Equip the loading area with dry powder extinguishers or other suitable fire extinguishing apparatus.
  - 5) Only trained personnel should be involved in loading and unloading air conditioners with flammable refrigerants.
  - 6) Prohibit smoking and open fires around the air conditioner to prevent fire hazards.
- **Transporting Management Requirements**
  - 1) The maximum transporting volume of finished products shall be determined as per local regulations.
  - 2) The vehicles used for transporting shall be operated as per local laws and regulations.
  - 3) Dedicated after-sales vehicles shall be used for maintenance transportation, and exposed transporting of refrigerant cylinders and the products to be maintained is not allowed.
  - 4) A rain cover or similar shield material of the transporting vehicles should have certain flame retardancy.
  - 5) Leakage warning device of flammable refrigerant shall be installed inside the closed-type compartment.
  - 6) Anti-static device shall be equipped inside the compartment of transporting vehicles.
  - 7) Dry powder extinguishers or other suitable fire extinguishing apparatus shall be equipped inside the driver's cab.
  - 8) The transporting vehicles shall run at a constant speed, and heavy acceleration/deceleration shall be avoided. High-temperature area shall be avoided during transporting, and necessary radiating measures shall be taken in case the temperature inside the compartment is too high
- **Storage Requirements**
  - 1) Ensure that the storage package of equipment prevents refrigerant leakage due to mechanical damage.
  - 2) Determine the maximum quantity of equipment allowed to be stored together according to local regulations.

# Installation Instructions

- **Installation Precautions**

WARNING!

- ★ Ensure that the room area where the R32 refrigerant air conditioner is installed meets the Transporting Management Requirements minimum requirement specified in the table below to prevent safety issues arising from refrigerant leakage.
- ★ Once the horn mouth of connecting lines is fastened, it should not be reused to maintain air tightness.
- ★ Use a whole connector wire for the indoor/outdoor unit as specified in the operation specification and operation instructions.
- ★ Manual should specify use of entire connection pipe.
- ★ Recommend placing joint of connection pipes at outdoor side; if not possible, non-reusable side must be installed indoors.
- ★ When reusing connection pipe, reinstall horn mouth

## R32 Air Conditioner Adding Extra Gas With Longer Pipe Calculator

Diameter of the liquid connecting pipe (mm)	Extra gas amount per meter after standard length (g)
ø6/ø6.35	20g
ø9/ø9.52	50g

Notes: The most gas amount should be: initial gas amount + extra gas amount < permitted gas by safety standard.

### Minimum Room Area

Type	LFL kg/m <sup>3</sup>	hv m	Total Mass Charged/kg Minimum Room Area/m <sup>2</sup>						
			4	7	10	15	20	30	50
R32	0.306	0.6	0.68	0.90	1.08	1.32	1.53	1.87	2.41
		1.0	1.14	1.51	1.80	2.20	2.54	3.12	4.02
		1.8	2.05	2.71	3.24	3.97	4.58	5.61	7.24
		2.2	2.50	3.31	3.96	4.85	5.60	6.86	8.85

- **Important Information Regarding The Refrigerant Used**

Product contains fluorinated greenhouse gases under Kyoto Protocol. Do not vent into the atmosphere. Refrigerant type: R32

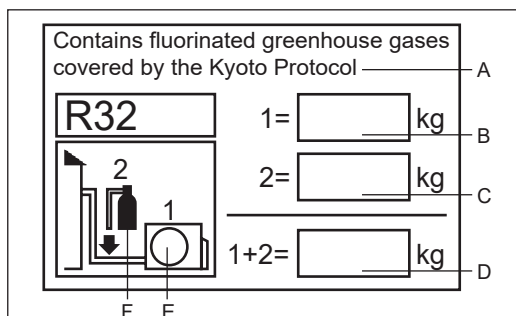

- A contains fluorinated greenhouse gases covered by the Kyoto Protocol
  - B factory refrigerant charge of the product: see unit name plate
  - C additional refrigerant amount charged in the field
  - D total refrigerant charge
  - E outdoor unit
  - F refrigerant cylinder and manifold for charging
- GWP=global warming potential

- 1 the factory refrigerant charge of the product
- 2 the additional refrigerant amount charged in the field
- 1+2 the total refrigerant charge
- 3 GWP\* value=675  
tCO<sub>2</sub>=(1+2) x 3 /1000

# Installation Instructions

Model	Factory charge (kg)	CO2 Equivalent(t)
1U26MADFRA	0.80	0.54
1U35MADFRA	0.84	0.57
1U53WADFRA	1.02	0.69
1U71WADFRA	1.10	0.74
1U25MAEFRA/1U25MAFFRA	1.00	0.68
1U35MAEFRA/1U35MAFFRA	1.02	0.69
1U50WAEFRA/1U50WAFFRA	1.02	0.69
1U60KAEFRA	1.30	0.88
1U71WAEFRA/1U71WAFFRA	1.42	0.96
1U80QAEFRA	1.62	1.09
1U90XADFRA	1.55	1.05
1U90QADFRA	1.55	1.05

## The maximum refrigerant charge amount (M)

Indoor unit	Outdoor unit	M kg	Indoor unit	Outdoor unit	M kg
AS26PBDHRA	1U26MADFRA	1.00	AS25QCFHRA	1U25MAFFRA	1.20
AS35PBDHRA	1U35MADFRA	1.04	AS35QCFHRA	1U35MAFFRA	1.22
AS53PDDHRA	1U53WADFRA	1.42	AS50QDFHRA	1U50WAFFRA	1.42
AS71PDDHRA	1U71WADFRA	1.50	AS71QEFHRA	1U71WAFFRA	1.62
AS90PFDHRA	1U90XADFRA	2.55	AS80QFFHRA	1U80QAEFRA	1.82
AS25QCEHRA	1U25MAEFRA	1.20	AS90QFDHRA	1U90QADFRA	2.55
AS35QCEHRA	1U35MAEFRA	1.22			
AS50QDEHRA	1U50WAEFRA	1.42			
AS60QEEHRA	1U60KAEFRA	1.50			
AS71QEEHRA	1U71WAEFRA	1.62			

- **Safety Awareness**

1. Procedures: Follow controlled procedures to reduce risks.
2. Area: Divide and isolate areas appropriately, avoid enclosed spaces. Ensure ventilation before starting refrigeration system or hot working.
3. Site inspection: Check refrigerant.
4. Fire control: Place fire extinguisher nearby, prohibit fire sources or high temperatures. Display "No smoking" signs.

- **Unpacking Inspection**

1. Indoor unit:
  - Check the red sign at the top of the green plastic seal cap on the evaporator air pipes after unpacking.
  - If the red sign is raised, nitrogen sealing is intact.
  - Press the black plastic seal cap at the joint of evaporator liquid pipes to check for nitrogen presence.
  - If no nitrogen is sprayed out, the indoor unit may have leakage, and installation is not allowed.
2. Outdoor unit:
  - Extend leak detection equipment into the packing box of the outdoor unit.
  - Check for refrigerant leakage.
  - If refrigerant leakage is detected, installation is not allowed, and the unit must be delivered to the maintenance department.

- **Inspection on Installation Environment**

1. Ensure the room area meets or exceeds the minimum area specified on the warning sign of the indoor unit.
2. For outdoor units of air conditioners using flammable refrigerants, avoid installing them inside enclosed rooms.
3. Avoid placing power supply outlets, switches, or other high-temperature objects such as fire sources or oil heaters beneath the indoor unit.
4. Ensure proper grounding of the power supply by providing an earthing wire and reliable earthing connection.
5. Before drilling holes in the wall, verify if there are any embedded water, electricity, or gas pipelines in the designated area. It is recommended to use existing through-wall holes whenever possible.
6. Damaged products must be taken to the maintenance point for repair. Welding of refrigerant pipelines on-site is not permitted.
7. Ensure the air conditioner's installation position allows for easy maintenance. Avoid placing obstacles near the indoor and outdoor unit air inlets/outlets and keep electrical appliances, power switches, sockets, valuables, and high-temperature items away from the indoor unit's sidelines.

# Installation Instructions

## • Safety Principles of Installation

1. Favorable ventilation shall be maintained at the place of installation (doors and windows are opened).
2. Open fire or high-temperature heat source (including welding, smoking and oven) higher than 548 °C is not allowed within the scope of flammable refrigerant.
3. Anti-static measures shall be taken, such as the wearing of cotton clothes and cotton gloves.
4. The place of installation shall be convenient for installation or maintenance, and cannot be adjacent to heat source and flammable and combustible environment.
5. In case of refrigerant leakage of the indoor unit during installation, the valve of the outdoor unit shall be closed immediately, and windows shall be opened, and all the personnel shall be evacuated. After the leakage of refrigerant is handled, the indoor environment shall be subject to concentration detection. Further handling is not allowed until the safety level is reached.
6. In case the product is damaged, it must be delivered to the maintenance point. Welding of refrigerant pipelines at the user's site is not allowed.
7. The installation position of air conditioner shall be convenient for installation or maintenance. Barriers shall be avoided around the air inlet/outlet of the indoor/outdoor unit, and the electrical appliance, power switches, sockets, valuables and high-temperature products within the scope of both sidelines of the indoor unit shall be avoided.



No fire source around the place of installation



Cotton clothes



Anti-static gloves



BEWARE ELECTROSTATICS



Goggles



Read operator' manual



Read technical manual



Operator' manual; operating instructions

## • Electrical Safety Requirements

Note:

1. Pay attention to surrounding conditions such as ambient temperature, direct sunlight, and rainwater during electrical wiring, and implement effective protective measures.
2. Use copper wire cables that comply with local standards for both the power line and connector wire.
3. Ensure both the indoor unit and outdoor unit are reliably earthed.
4. Complete wiring for the outdoor unit before proceeding with the indoor unit. Power on the air conditioner only after completing wiring and pipe connections.
5. Use a dedicated branch circuit and install a leakage protector with sufficient capacity.

## • Qualification Requirements of Installer

Relevant qualification certificate must be obtained as per national laws and regulations.

## • Indoor Unit Installation

### 1. Fixation of wall panel and piping layout

If the left/right water pipe connection for the indoor unit is necessary, or if the evaporator interface of the indoor unit and the horn mouth of the connecting piping cannot be extended to the outdoor side for installation, the connector pipes shall be connected to the evaporator piping interface of the indoor unit during the horn mouth process.

### 2. Piping layout

During the layout of connecting pipes, drain hose, and connector wires, adhere to the following guidelines:

- Place the drain hose at the bottom and the connector wire at the top.
- Avoid intertwining the power line with the connector wire.
- Ensure proper ventilation and thermal insulation for drain pipes, especially those inside the room and machine.

# Installation Instructions

## 3. Nitrogen charging for pressure maintaining and leak detection

After connecting the evaporator of the indoor unit to the connector pipe and welding, follow these steps for pressure testing and leak detection:

1. Charge nitrogen at a pressure above 4.0MPa into the evaporator and the connected piping using a nitrogen cylinder equipped with a reducing valve. Close the valve of the nitrogen cylinder and perform leak detection using soapy water or a leak detecting solution. Maintain the pressure for at least 5 minutes and observe if the system pressure decreases, indicating a leak. If a leak is detected, address the leak point and repeat the process.

2. After connecting the evaporator of the indoor unit to the connecting piping, charge nitrogen for pressure maintenance and leak detection. Then connect the evaporator to the two-way stop valve and three-way stop valve of the outdoor unit. After fastening the copper cap of the connecting piping, charge nitrogen above 4.0MPa at the access hole of the three-way stop valve using a charging hose. Perform leak detection as described above.

3. Alternatively, perform the above steps after connecting the indoor unit to the connecting pipelines and the two-way stop valve and three-way stop valve of the outdoor unit. Connect the access hole of the outdoor unit to the nitrogen cylinder and pressure gauge and charge nitrogen above 4.0MPa. Ensure each joint is accessible for leak detection.

After completing the installation steps and ensuring no leaks, proceed with vacuuming using a vacuum pump.

### • Outdoor Unit Installation

#### 1. Fixation and connection

Note:

- a) Avoid any fire sources within a 3-meter radius around the installation site.
- b) Place the refrigerant leak detection equipment at a low position outdoors and ensure it is open.

##### 1) Mounting

Attach the outdoor unit securely to the wall surface, ensuring horizontal alignment. For wall or roof installations, firmly secure the support to prevent damage from strong winds.

##### 2) Connecting Pipe Installation

Align the cone of the connecting pipes with the conical surface of the valve connector. Install the nut of the connecting pipes in the correct position and tighten it using a spanner. Avoid excessive torque to prevent damage to the nut.



### • Vacuuming

Utilize a digital vacuum gauge during the evacuation process. Maintain the vacuum for a minimum of 15 minutes, ensuring the pressure on the gauge remains below 60Pa. Once completed, close the vacuum equipment and observe the digital gauge reading for any increase in pressure over 5 minutes. If no leaks are detected, proceed to open the two-way and three-way stop valves on the outdoor unit. Finally, disconnect the vacuum hose from the outdoor unit.

### • Leak Testing

Check the joints of the connecting pipes for the outdoor unit using either soap bubbles or specialized leak detection equipment.



- **Post-installation Inspection Items and Test Run**

### Post-installation Inspection Items

Items to Be Checked	Consequence of Improper Installation
Whether the installation is firm or not	The unit may fall, vibrate or make a noise
Whether the inspection on air leakage is complete	The refrigerating capacity (heating capacity) may be insufficient
Whether the unit is fully insulated	Condensation or drip may occur
Whether the drainage is smooth or not	Condensation or drip may occur
Whether the power voltage is identical to that marked on the nameplate	Failure may occur or the parts may be burned
Whether the circuit and pipeline are installed correctly	Failure may occur or the parts may be burned
Whether the unit is safely earthed	Electric leakage may occur
Whether the type of wire is in line with relevant regulations	Failure may occur or the parts may be burned
Whether barriers are identified at the air inlet/outlet of the indoor/outdoor unit	The refrigerating capacity (heating capacity) may be insufficient
Whether the length of refrigerant pipes and the refrigerant amount charged are recorded	The refrigerant amount charged cannot be confirmed

### Test Run

1. Preparations
  - 1) Power must not be turned on until all installation tasks are finished and leak detection is confirmed.
  - 2) Ensure correct connection of the control circuit with all wires securely fastened.
  - 3) Open the two-way and three-way stop valves.
  - 4) Clean the unit thoroughly, removing any scattered items, particularly metal filings and thread residues.
2. Methods
  - 1) Activate the power supply and use the remote controller to press "ON/OFF" to start the air conditioner.
  - 2) Press "Mode" to choose between refrigeration, heating, and fan modes, then observe the air conditioner for normal operation.

### 1. DRED Installation Instruction

Please consult your reseller and/or installer to determine if you have a DRED appliance.

#### 1 Open cover piece and locate board.

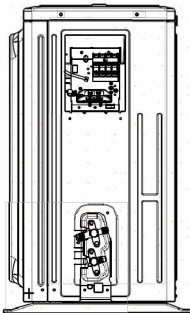

1U26MADFRA  
1U35MADFRA  
1U25MAEFRA  
1U35MAEFRA  
1U25MAFFRA  
1U35MAFFRA

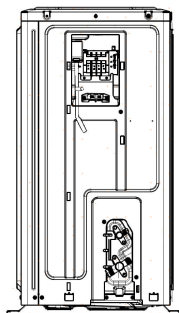

1U53WADFRA  
1U71WADFRA  
1U50WAEFRA  
1U71WAEFRA  
1U50WAFFRA  
1U71WAFFRA

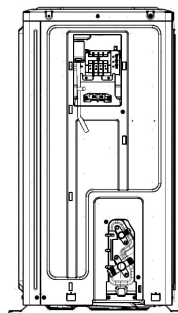

1U60KAEFRA

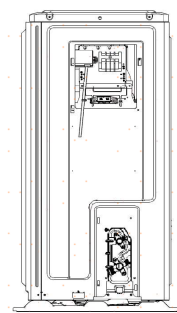

1U80QAFFRA  
1U90XADFRA  
1U90QADFRA

- 2 The installation position of the DRED (Demand Response Enabling Device) module should be selected based on the specific outdoor unit and the type of electrical box coupling being used.

# Relocation Procedures

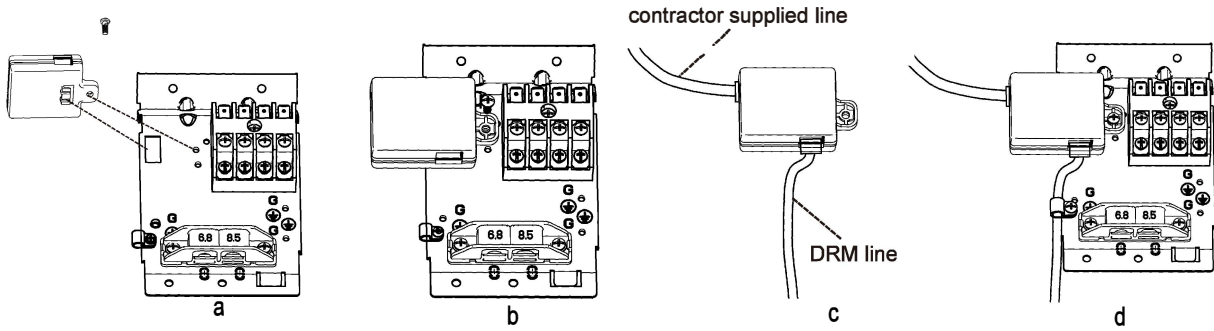

- Attach the OREO module to the board using the bayonet mechanism.
- Use screws to secure the OREO module firmly.
- Connect the contractor-supplied line to the ORM line.
- Use a clamp to secure the ORM line and fasten it with a screw.
- Connect the contractor-supplied line to the PCB via interface CN14.

3 Refit the stop valve cover.

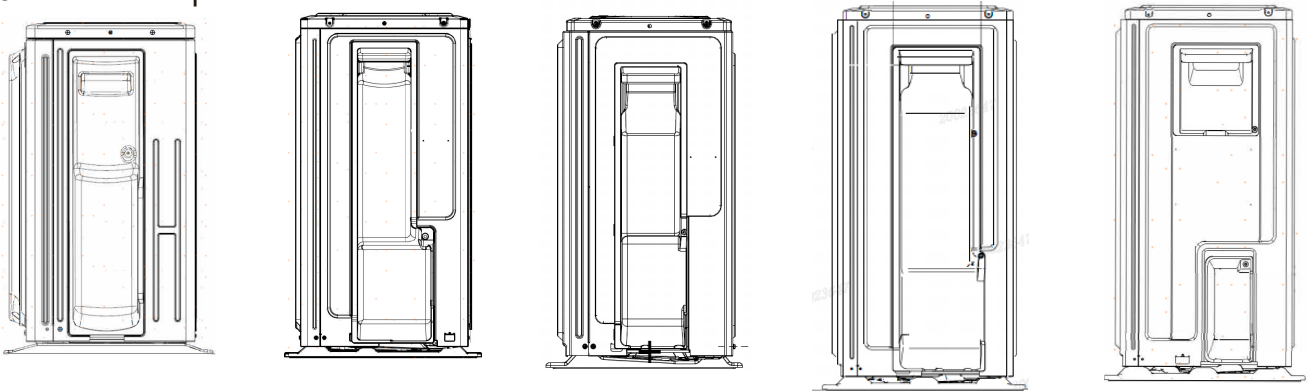

## Relocation Procedures

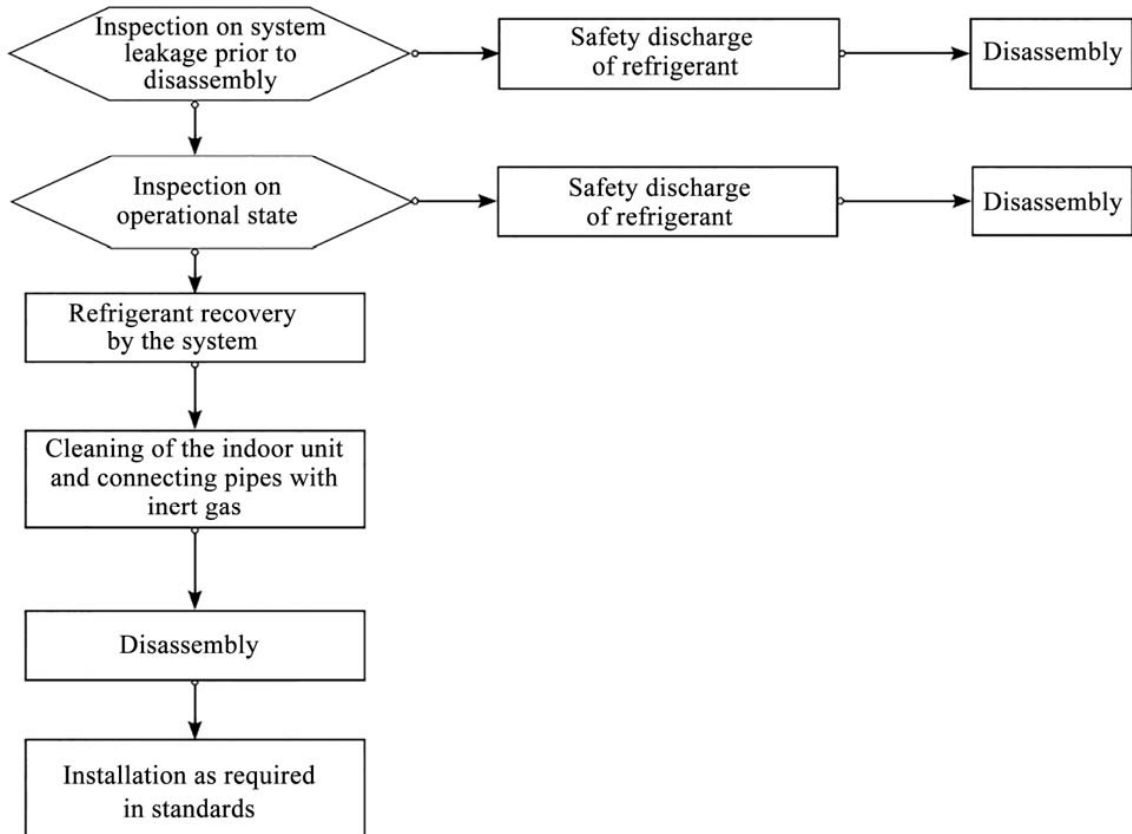

Note: If relocation is necessary, cut off the joint of the evaporator gas/liquid pipes of the indoor unit using a cutting knife. Reconnection is permitted only after re-flaring, following the same procedure for the outdoor unit.

# Maintenance Instructions

---

## Maintenance Precautions

### Precautions

- Maintenance involving welding of refrigeration pipelines or components within the R32 refrigerant air conditioner system should never be conducted at the user's site.
- Tasks necessitating extensive disassembly and bending operations on the heat exchanger, such as replacing the outdoor unit chassis or fully disassembling the condenser, are strictly prohibited from being performed at the user's site.
- Replacement of the compressor or refrigeration system components is not permitted to be carried out at the user's site.
- Other faults not affecting the refrigerant container, internal refrigeration pipelines, or refrigeration elements may be addressed at the user's site, including cleaning and clearing the refrigeration system without disassembling refrigeration elements or welding.
- If replacement of gas/liquid pipes is needed during maintenance, the joint of the indoor unit's evaporator gas/liquid pipes must be cut with a cutting knife. Reconnection is only permissible after re-flaring, following the same procedure as for the outdoor unit.

### Qualification Requirements of Maintenance Personnel

- Every operator or maintenance personnel involved in refrigerating circuits must possess a valid certificate issued by an industry-recognized assessment institute, ensuring their qualification for safely handling refrigerants in compliance with assessment regulations.
- Maintenance and repairs of the equipment should strictly adhere to the manufacturer's recommended methods. If assistance from personnel from other disciplines is needed, it must be supervised by personnel holding certification in handling flammable refrigerants.

### Inspection on Maintenance Environment

- Prior to operation, any leaked refrigerant in the room must be cleared.
- The maintenance area's dimensions should align with those specified on the equipment's nameplate.
- Adequate ventilation must be maintained throughout the maintenance process.
- Open flames or heat sources exceeding 548 degrees, capable of igniting easily, are strictly prohibited within the maintenance area.
- All operators in the maintenance area must power off their phones and any electronic devices emitting radiation during maintenance.
- A functioning dry powder or carbon dioxide extinguisher must be readily available inside the maintenance area.

### Maintenance Site Requirements

- The maintenance site must have adequate ventilation and be level. Setting up the maintenance site in a basement is not permitted.
- Clearly demarcate welding and non-welding zones at the maintenance site, ensuring a safe distance between them.
- Install ventilators, exhaust fans, ceiling fans, floor fans, and dedicated exhaust ducts to meet ventilation and exhaust requirements, preventing the accumulation of refrigerant gas.
- Equip flammable refrigerant leak detection devices and establish a management system for their maintenance. Confirm the availability of leak detection equipment before commencing maintenance.
- Provide sufficient dedicated vacuum pumps and refrigerant charging equipment for flammable refrigerants, with a management system ensuring each equipment is used exclusively for one type of refrigerant.
- Install the main power switch outside the maintenance site, equipped with protective (anti-explosive) devices.
- Store nitrogen, acetylene, and oxygen cylinders separately, with a minimum distance of 6m between gas cylinders and areas involving open flames. Acetylene cylinders should be equipped with anti-backfire valves, and their colors must meet international standards.
- Display "No Fire" warning signs within the maintenance area.
- Equip fire control devices suitable for electrical appliances such as dry powder or carbon dioxide extinguishers, ensuring they are always available for use.

# Maintenance Instructions

---

- The ventilator and other electrical equipment at the maintenance site must be securely fixed with standardized pipe routing. Temporary wires and sockets are strictly prohibited at the maintenance site.

## Leak Detection Methods

- The area where refrigerant leakage is checked must be free from potential ignition sources. Avoid using halogen probes or detectors with open flames for leak detection.
- For systems containing flammable refrigerants, electronic leak detection equipment may be used. During calibration and use, ensure the environment is free from refrigerant and that the equipment does not pose an ignition risk. It should also be suitable for the refrigerant being detected. The equipment should be set to a percentage of the Lower Flammable Limit (LFL) of the refrigerant and calibrated accordingly, with gas concentrations kept within safe limits (up to 25% maximum).
- The fluid used for leak detection should be compatible with most refrigerants. Avoid using chlorine-containing solvents to prevent chemical reactions with refrigerants and corrosion of copper pipelines.
- If a leak is suspected, evacuate or extinguish any open flames in the vicinity.
- If welding is necessary at the leak site, either recover all refrigerants or isolate them far from the leak point using a stop valve. Before and during welding, the entire system should be purged with Oxygen-Free Nitrogen (OFN).

## Maintenance Items

### Maintenance Requirements

- Before operating the refrigeration system, clean the circulating system with nitrogen. Next, vacuumize the outdoor unit for a duration of no less than 30 minutes. Finally, utilize 1.5~2.0MPa OFN for nitrogen flushing (lasting 30 seconds to 1 minute) to pinpoint areas requiring treatment. Maintenance of the refrigeration system is permissible only after removing any residual gas of flammable refrigerant.
- When using refrigerant charging tools, prevent cross-contamination of different refrigerants, and minimize the total length (including refrigerant pipelines) to reduce residual refrigerant.
- Ensure refrigerant cylinders are kept upright and securely fixed.
- Ground the refrigeration system before charging refrigerant.
- Charge the specified type and volume of refrigerant as indicated on the nameplate; excessive charging is prohibited.
- Seal the refrigeration system securely after maintenance.
- Ensure that ongoing maintenance does not compromise or reduce the original safety protection level of the system.

### Maintenance of Electrical Components

- During maintenance, inspect a portion of the electrical components for refrigerant leakage using dedicated leak detection equipment.
- Post-maintenance, refrain from disassembling or removing components with safety protection functions.
- When conducting maintenance on sealing elements, power off the air conditioner before opening the seal cover. If power supply is necessary, conduct continuous leak detection at the most critical position to mitigate potential risks.
- Replacement of enclosures during maintenance of electrical components should not compromise the level of protection.
- After maintenance, ensure that sealing functions remain intact and sealing materials do not lose their ability to prevent the entry of flammable gas due to aging. Substituted components should meet the manufacturer's recommended requirements for the air conditioner.

### Maintenance of Intrinsically Safe Elements

The intrinsically safe element refers to the components working continuously inside flammable gas without any risks.

# Maintenance Instructions

---

- Prior to any maintenance, perform leak detection and inspect the grounding reliability of the air conditioner to ensure no leaks and reliable grounding.
- If the service of the air conditioner may exceed the allowable voltage and current limits, do not add any inductance or capacitance to the circuit.
- Use only parts and components designated by the air conditioner manufacturer for replacement, as using unauthorized parts may pose a fire hazard in the event of refrigerant leakage.
- If maintenance work does not involve system pipelines, ensure that the pipelines are well protected to prevent any leaks during maintenance.
- After maintenance and before conducting a test run, perform leak detection and inspect the grounding reliability of the air conditioner using leak detection equipment or a leak-detecting solution. Ensure that the startup inspection is conducted without any leaks and with reliable grounding.

## Removal and Vacuumizing

Maintenance or other operations on the refrigeration circuit should adhere to conventional procedures, with a primary consideration on the flammability of the refrigerant. The following steps should be followed:

1. Refrigerant clearing
2. Pipeline purification with inert gas
3. Vacuumizing
4. Pipeline purification again with inert gas
5. Pipeline cutting or welding, with the refrigerant recovered into a suitable cylinder. The system should then be purged with Oxygen-Free Nitrogen (OFN) for safety. This step may need to be repeated several times, and compressed air or oxygen should not be used for purging.

During purging, OFN should be charged into the refrigeration system while under a vacuum to reach operating pressure. Subsequently, the OFN should be discharged into the atmosphere. Finally, vacuumizing of the system should be performed. This process should be repeated until all refrigerants in the system are cleared. The OFN charged for the last time should also be discharged into the atmosphere before welding can occur. This procedure is essential for pipeline welding.

Ensure that no open flame sources are near the outlet of the vacuum pump, and that ventilation is adequate.

## Welding

- Adequate ventilation in the maintenance area must be ensured. After the maintenance machine undergoes the vacuumizing process, the system refrigerant can be discharged on the outdoor unit side.
- Before welding the outdoor unit, ensure that no refrigerant remains inside and that the system refrigerant has been discharged and cleared.
- Under no circumstances should refrigeration pipelines be cut with a welding gun. Instead, disassemble the refrigeration pipelines using a pipe cutter, ensuring that the disassembly is conducted around a ventilation opening.

## Refrigerant Charging Procedures

### Additional requirements to conventional procedures:

- Ensure refrigerant charging tools are used without cross-contamination of different refrigerants. Minimize the total length of the system (including refrigerant pipelines) to reduce residual refrigerant.
- Store refrigerant cylinders upright.
- Ground the refrigeration system before charging refrigerant.
- Apply a label to the refrigeration system after refrigerant charging.
- Avoid excessive charging; charge refrigerant slowly.
- If system leakage is detected, refrain from charging refrigerant until the leak point is sealed.
- During refrigerant charging, measure the amount using an electronic or spring scale. Ensure the connecting hose between the refrigerant cylinder and charging equipment is appropriately relaxed to maintain measurement accuracy and avoid stress.

### Storage site requirements for refrigerant:

- Store refrigerant cylinders in an environment with temperatures ranging from -10°C to 50°C, with adequate ventilation. Apply warning labels.
- Store and use maintenance tools in contact with refrigerant separately, ensuring tools for different refrigerants are not mixed.

# Scrapping and Recovery

---

## Scrapping

Before scrapping, the technician shall be completely familiar with the equipment and all its features. The safe recovery of refrigerant is recommended. In case the refrigerant recovered needs to be reused, before which the sample of refrigerant and oil shall be analyzed. The power supply required shall be guaranteed before tests.

- (1) The equipment and operation shall be well known;
- (2) Power supply shall be switched off;
- (3) The followings shall be guaranteed before scrapping:
  - The mechanical equipment shall be convenient for operation on the cylinder of refrigerant (if necessary);
  - All personal protective equipment is available and being used correctly;
  - The whole course of recovery shall be guided by qualified personnel;
  - The recovery equipment and cylinders shall be in line with corresponding standards.
- (4) The refrigeration system shall be vacuumised if possible;
- (5) If the vacuum state cannot be reached, vacuumising should be conducted from multiple positions to remove refrigerant from each part of the system.
- (6) Ensure that cylinder capacities are sufficient before recovery.
- (7) Operate the recovery equipment according to the manufacturer's instructions.
- (8) Do not overfill the cylinder. The refrigerant charged should not exceed 80% of the cylinder's capacity.
- (9) Do not exceed the maximum operating pressure of cylinders, even for short periods.
- (10) After refrigerant charging is completed, rapidly evacuate the cylinder and equipment, and close all stop valves on the equipment.
- (11) Refrigerant recovered must not be charged into another refrigeration system before purification and testing.

### Note:

**After scrapping the air conditioner and discharging the refrigerant, mark the air conditioner (with dates and signature). Ensure that the marking on the air conditioner reflects the flammable refrigerant charged inside.**

## Recovery

During maintenance or scrapping, it's essential to thoroughly clear the refrigerant from the refrigeration system.

- 1) Refrigerant should only be charged into dedicated cylinders with capacities matching the refrigerant amount in the system. These cylinders should be labeled accordingly and equipped with pressure relief valves and stop valves. Empty cylinders should be vacuumised before use and stored at normal temperature if possible.
- 2) The recovery equipment should always be in good working condition and equipped with operation instructions for easy reference. It should be suitable for recovering flammable refrigerants and equipped with weighing apparatus with valid measurement certificates. Removable attachment joints for hoses, free from leaks, should always be maintained. Check the condition of the recovery equipment and all electrical components before use to prevent fire in case of refrigerant leakage. Contact your local dealer or qualified personnel if you have any questions.
- 3) Recovered refrigerant should be returned to the manufacturer in appropriate cylinders with attached transportation instructions. Mixing refrigerants in recovery equipment, especially cylinders, is prohibited.
- 4) During transportation, the space where flammable refrigerant air conditioners are loaded must not be sealed. If necessary, anti-static measures should be taken for transporting vehicles. Additionally, necessary protective measures should be taken during loading and unloading to prevent damage to the air conditioners.
- 5) When removing the compressor or clearing compressor oil, ensure the compressor is vacuumised to remove any residual flammable refrigerant from the lubricating oil. Vacuumising should be completed before returning the compressor to the manufacturer. Vacuumising can only be accelerated by heating the compressor housing through electrical heating. Safety measures should be observed when discharging oil from the system.

# Indoor/Outdoor Unit Installation Drawings

The models adopt HFC free refrigerant R32.

For installation of the indoor units, refer to the installation manual which was provided with the units. (The diagram shows a wall-mounted indoor unit.)

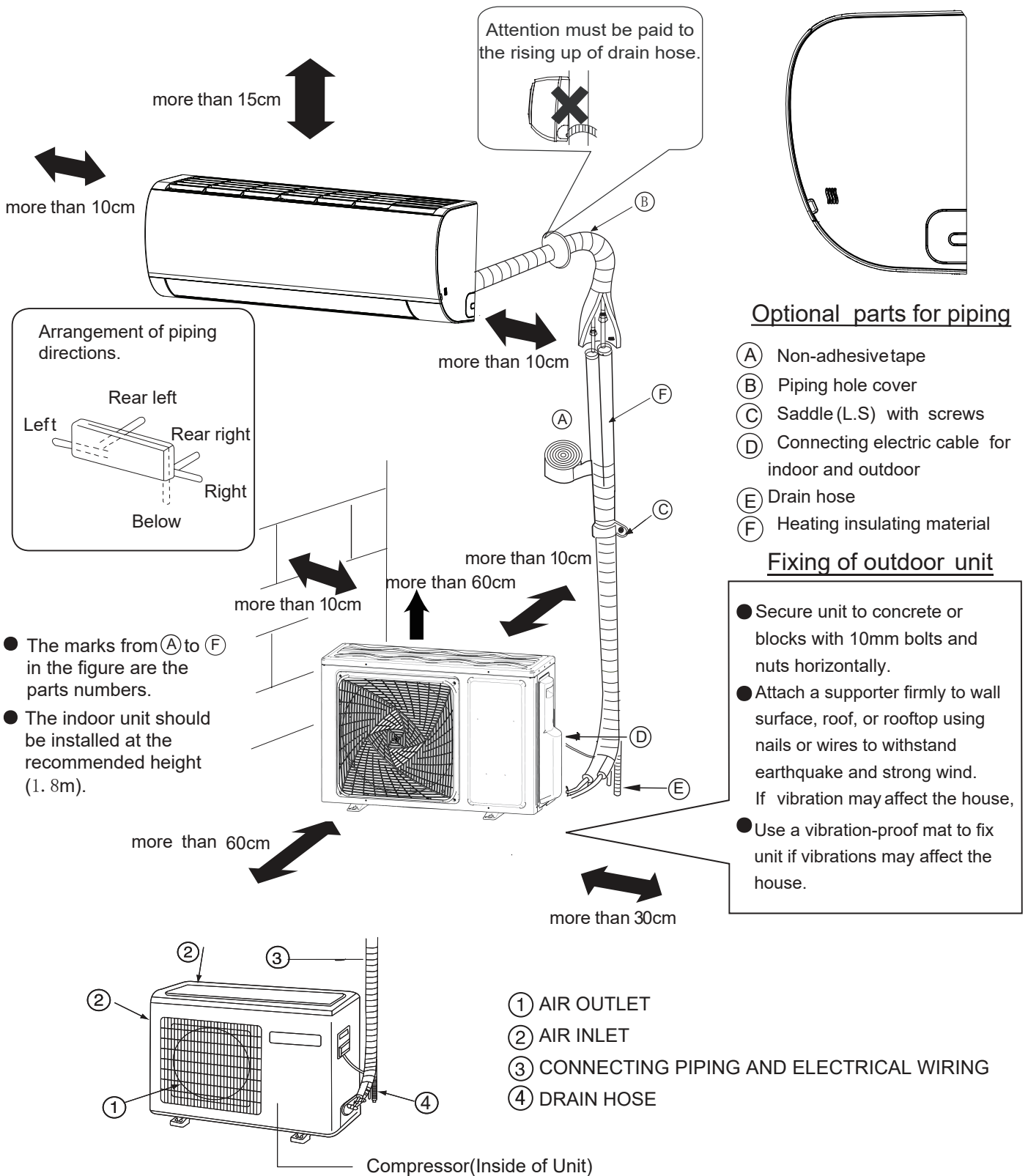

1. When installing the unit on a wall, roof, or rooftop, securely attach a supporter using screws or wires to prepare for earthquakes and strong winds.
2. Mount the air conditioner at a location not directly above and at least one meter away from electrical equipment such as television.

Please be subjected to the actual product purchased.

# Safety Precautions

## ⚠ WARNING

- |   |   |
|---|---|
| <ul style="list-style-type: none"> <li>• Have the unit professionally installed. Improper installation by an unqualified person may result in water leak, electric shock, or fire.</li> <li>• Place the unit on a stable, level surface capable of withstanding its weight to prevent tipping over or falling, which could cause injury.</li> <li>• Only use specified cables for wiring.</li> <li>• Securely connect each cable, ensuring they are not straining the terminals.</li> <li>• Improperly connected cables may generate heat and cause a fire.</li> <li>• Take necessary safety measures against typhoons and earthquakes to prevent the unit from falling over.</li> <li>• Do not make any changes or modifications to the unit. In case of problems, consult the dealer. If repairs are not made properly, the unit may leak water and present a risk of electric shock, or it may produce smoke or cause fire.</li> </ul> | <ul style="list-style-type: none"> <li>• Be sure to carefully follow each step in this handbook when installing the unit. Improper installation may result in water leak, electric shock, fire or explosion.</li> <li>• Have all electrical work performed by a licensed electrician according to the local regulations and the instructions given in this manual. Secure a circuit designated exclusively to the unit. Improper installation or a lack of circuit capacity may cause the unit to malfunction or present a risk of electric shock, fire or explosion.</li> <li>• Securely attach the terminal cover(panel) on the unit. If installed improperly, dust and/or water may enter the unit and present a risk of electric shock, smoke or fire.</li> <li>• Using any refrigerant other than the specified type or introducing air into the unit circuit may cause the unit to run abnormally and potentially burst.</li> </ul> |
|---|---|

## ⚠ WARNING

- |  |  |
|--|--|
| <ul style="list-style-type: none"> <li>• Do not touch the fins on the heat exchanger with bare hands, for they are sharp and dangerous.</li> <li>• In the event of a refrigerant gas leak, provide adequate ventilation to the room. If leaked refrigerant gas is exposed to a heat source, noxious gases, fire or explosion will be caused.</li> <li>• Do not try to defeat the safety features of the devices, and do not change the settings. Defeating the safety features on the unit such as the pressure switch and temperature switch or using parts other than the dealer or specialist may result in fire or explosion.</li> </ul> | <ul style="list-style-type: none"> <li>• When installing the unit in a small room, safeguard against hypoxia that results from leaked refrigerant reaching the threshold level. Consult the dealer for necessary measures to take.</li> <li>• When relocating the air conditioner, consult the dealer or a specialist. Improper installation may result in water leak, electric shock, fire or explosion.</li> <li>• After completing the service work, check for a refrigerant gas leak. If leaked gas refrigerant is exposed to a heat source such as fan heater, stove, and electric grill, noxious gases, fire or explosion.</li> <li>• Only use specified parts. Have the unit professionally installed. Improper installation may cause water leak, electric shock, smoke, fire, explosion.</li> </ul> |
|--|--|

### Precautions for Handling Units for Use with R32

## ⚠ Caution

- |   |   |
|---|---|
| <p>Do not use the existing refrigerant piping</p> <ul style="list-style-type: none"> <li>• The old refrigerant and refrigerator oil in the existing piping contain a large amount of chlorine, which will cause the refrigerator oil in the new unit to deteriorate.</li> <li>• R32 is a high-pressure refrigerant, and the use of the existing piping may result in bursting.</li> </ul> <p>Keep the inner and outer surfaces of the pipes clean and free of contaminants such as sulfur, oxides, dust/dirt shaving particles, oils, and moisture.</p> <ul style="list-style-type: none"> <li>• Contaminants inside the refrigerant piping will cause the refrigerant oil to deteriorate.</li> </ul> | <p>Use a vacuum pump with a reverse-flow check valve.</p> <ul style="list-style-type: none"> <li>• If other types of valves are used, the vacuum pump oil will flow back into the refrigerant cycle and cause the refrigerator oil to deteriorate.</li> </ul> <p>Do not use the following tools that have been used with the conventional refrigerants. Prepare tools that are for exclusive use with R32 .<br/>(Gauge manifold, charging hose, gas leak detector, reverse-flow check valve, refrigerant charge base, vacuum gauge, and refrigerant recovery equipment.)</p> <ul style="list-style-type: none"> <li>• If refrigerant and/or refrigerant oil left on these tools are mixed in with R32 , or if water is mixed with R32 , it will cause the refrigerant to deteriorate.</li> <li>• Since R32 does not contain chlorine, gas-leak detectors for conventional HFC refrigerants will not work</li> </ul> |
|---|---|



# Safety Precautions

## ⚠ Caution

Store the piping to be used during installation indoors, and keep both ends of the piping sealed until immediately before brazing.(keep elbows and other joints wrapped in plastic.)

- If dust, dirt, or water enters the refrigerant cycle, it may cause the oil in the unit to deteriorate or may cause the compressor to malfunction.

Use a small amount of ester oil, ether oil, or alkylbenzene to coat flares and flange connections.

- A large amount of mineral oil will cause the refrigerating machine oil to deteriorate.

Use liquid refrigerant to charge the system.

- Charge the unit with gas refrigerant will cause the refrigerant in the cylinder to change its composition and will lead to a drop in performance

Do not use a charging cylinder.

- The use of charging cylinder will change the composition of the refrigerant and lead to power loss.

Exercise special care when handling the tools.

- An introduction of foreign objects such as dust, dirt or water into the refrigerant cycle will cause the refrigerating machine oil to deteriorate.

Only use R32 refrigerant.

- The use of refrigerants containing chlorine(i.e. R22) will cause the refrigerant to deteriorate.

## Before Installing the Unit

## ⚠ Caution

Do not install the unit in a place where there is a possibility of flammable gas leak.

- Leaked gas accumulated around the unit may start a fire.

Do not use the unit to preserve food, animals, plants, artifacts, or for other special purposes.

- The unit is not designed to provide adequate conditions to preserve the quality of these items.

Do not use the unit in an unusual environment

- The use of the unit in the presence of a large amount of oil, steam, acid, alkaline solvents or special types of sprays may lead to a remarkable drop in performance and/or malfunction and presents a risk of electric shock, smoke, or fire.
- The presence of organic solvents, corroded gas (such as ammonia, sulfur compounds, and acid may cause gas or water leak.)

When installing the unit in a hospital, take necessary measures against noise.

- High-frequency medical equipment may interfere with the normal operation of the air conditioning unit or the air conditioning unit may interfere with the normal operation of the medical equipment

Do not place the unit on or over things that may not get wet.

- When humidity level exceeds 80% or when the drainage system is clogged, indoor units may drip water.
- Installation of a centralized drainage system for the outdoor unit may also need to be considered to prevent water drips from the outdoor units.

Carefully read the following information in order to operate the air conditioner correctly.

Below are listed three kinds of Safety Precautions and Suggestions.

**⚠ WARNING** Incorrect operations may result in severe consequences of death or serious injuries.

**⚠ CAUTION** Incorrect operations may result in injuries or machine damages; in some cases may cause serious consequences.

**INSTRUCTIONS:** These information can ensure the correct operation of the machine.

Symbols used in the illustrations

⊘ :Indicates an action that must be avoided.

⦿ :Indicates that important instructions must be followed.

⚡ :Indicates a part which must be grounded.

⚡ :Beware of electric shock (This symbol is displayed on the main unit label.)

After reading this handbook, hand it over to those who will be using the unit.

The user of the unit should keep this manual at hand and make it available to those who will be performing repairs or relocating the unit. Also, make it available to the new user when the user changes hands.

Be sure to conform with the following important Safety Precautions.

## ⚠ WARNING

- If any abnormal phenomena is found (e. g.smell of firing), please cut off the power supply immediately, and contact the dealer to find out the handling method.  
Open the window and well ventilated the room.  
In such case, to continue using the conditioner will damage the conditioner, and may cause electrical shock or fire hazard.
- After a long time use of air-conditioner the base should be checked for any damages.  
If the damaged base is not repaired, the unit may fall down and cause accidents.

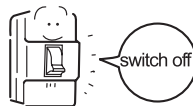

- Don't dismantle the outlet of the outdoor unit.  
The exposure of fan is very dangerous which may harm human beings.
- When need maintenance and repairment, call dealer to handle it.  
Incorrect maintenance and repairment may cause water leak, electrical shock and fire hazard.



# Safety Precautions

## ⚠ WARNING

- If any abnormal phenomena is found (e. g. smell of firing), please cut off the power supply immediately, and contact the dealer to find out the handling method.  
Open the window and well ventilated the room.  
In such a case, continuing to use the conditioner may damage it and pose risks of electrical shock or fire hazards.
- After prolonged use of the air conditioner, it's advisable to check the base for any damages.  
If the damaged base is not repaired, the unit may fall down and cause accidents.
- No goods or nobody is permitted to placed on or stand on outdoor unit. The falling of goods and people may cause accidents.
- Don't operate the air-conditioner with damp hands. Otherwise it will be shocked.
- Only use explosion-proof fuse .  
May not use wire or any other materials replacing fuse, otherwise it may cause faults or fire accidents.
- Use discharge pipe correctly to ensure efficient discharge.  
Incorrect pipe use may cause water leaking.
- Installed electrical-leaking circuit breaker.  
It easily cause electrical shock without circuit breaker.

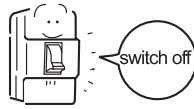

- Don't dismantle the outlet of the outdoor unit.  
The exposure of fan is very dangerous which may harm human beings.
- When need maintenance and repairment, call dealer to handle it.  
Incorrect maintenance and repairment may cause water leak, electrical shock and fire hazard.
- Air-conditioner can't be installed in the environment with inflammable gases because the inflammable gases near air-conditioner may cause fire hazard.  
Please let the dealer be responsible for installing the conditioner. Incorrect installation may cause water leak, electrical shock and fire hazard.
- Call the dealer to take measures to prevent the refrigerant from leaking.  
If conditioner is installed in a small room, be sure to take every measure in order to prevent suffocation accident even in case of refrigerant leakage.
- When conditioner is installed or reinstalled, the dealer should be responsible for them.  
Incorrect installation may cause water leaking, electrical shock and fire hazard.
- Connect earthing wire.  
Earthing wire should not be connected to the gas pipe, water pipe, lightning rod or phone line, incorrect earthing may cause shock.



Earthing

## Before Installing (Relocating) the Unit or Performing Electric Work

### ⚠ Caution

- Ground the unit.
- Do not connect the grounding on the unit to gas pipes, water pipes, lightning rods, or the grounding terminals of telephones. Improper grounding presents a risk of electric shock, smoke, fire, or the noise caused by improper grounding may cause the unit to malfunction.
- Make sure the wires are not subject to tension.
- If the wires are too taut, they may break or generate heat and/or smoke and cause fire.
- Install a explosion-proof breaker for current leakage at the power source to avoid the risk of the electric shock.
- Lack of a breaker for current leakage can pose risks of electric shock, fire, or explosion.
  - Do not use large-capacity fuses, steel wire, or copper wire. Damaging the unit, fire, smoke or explosion will be caused otherwise.

- Do not spray water on the air conditioners or immerse the air conditioners in water.
- Water on the unit presents a risk of electric shock. Periodically check the platform on which is placed for damage to prevent the unit from falling.
  - If the unit is left on a damaged platform, it may topple over, causing injury.
- When installing draining pipes, follow the instructions in the manual, and make sure that they properly drain water so as to avoid dew condensation.
- If not installed properly, they may cause water leaks and damage the furnishings.
- Properly dispose of the packing materials.
- Things such as nails may be included in the package. Dispose of them properly to prevent injury. Plastic bags present a choking hazard to children. Tear up the plastic bags before disposing of them to prevent accidents.

## Before the Test Run

### ⚠ Caution

- Do not operate switches with wet hands to avoid electric. Do not touch the refrigerant pipes with bare hands during and immediately after operation.
- Depending on the state of the refrigerant in the system, certain parts of the unit such as the pipes and compressor may become very cold or hot and may subject the person to frost bites or burning.
- Do not operated the unit without panels and safety guards in their proper places.
- They are there to keep the users from injury from accidentally touching rotating, high-temperature or high-voltage parts.

- Do not turn off the power immediately after stopping the unit.
- Allow for at least five minutes before turning off the unit, otherwise the unit may leak water or experience other problems.
- Do not operate the unit without air filters.
- Dust particles in the air may clog the system and cause malfunction.

# Read Before Installation

## Items to Be Checked

- (1). Verify the type of refrigerant used by the unit to be serviced. Refrigerant Type: R32
- (2). Check the symptom exhibited by the unit to be serviced. Look in this service handbook for symptoms relating to the refrigerant cycle.
- (3). Be sure to carefully read the safety precautions at the beginning of this document.
- (4). If there is a gas leak or if the remaining refrigerant is exposed to an open flame, a noxious gas hydrofluoric acid may form. Keep workplace well ventilated.

## CAUTION

- Install new pipes immediately after removing old ones to keep moisture out of the refrigerant circuit.
- Chloride in some types of refrigerants such as R22 will cause the refrigerating machine oil to deteriorate.

## Necessary Tools and Materials

Prepare the following tools and materials necessary for installing and servicing the unit.

Necessary tools for use with R32 (Adaptability of tools that are for use with R22 and R407C).

1. To be used exclusively with R32 ( Not to be used if used with R22 or R407C )

Tools/Materials	Use	Notes
Gauge Manifold	Evacuating, refrigerant charging	5.09MPa on the High-pressure side.
Charging Hose	Evacuating, refrigerant charging	Hose diameter larger than the conventional ones.
Refrigerant Recovery Equipment	Refrigerant recovery	
Refrigerant Cylinder	Refrigerant charging	Write down the refrigerant type. Pink in color at the top of the cylinder.
Refrigerant Cylinder Charging Port	Refrigerant charging	Hose diameter larger than the conventional ones.
Flare Nut	Connecting the unit to piping	Use Type-2 Flare nuts.

2. Tools and materials that may be used with R32 with some restrictions

Tools/Materials	Use	Notes
Gas leak detector	Detection of gas leaks	The ones for HFC type refrigerant may be used.
Vacuum Pump	Vacuum drying	May be used if a reverse flow check adaptor is attached.
Flare Tool	Flare machining of piping	Charges have been made in the flare machining dimension. Refer to the next page.
Refrigerant Recovery Equipment	Recovery of refrigerant	May be used if designed for use with R32 .

3. Tools and materials that are used with R22 or R407C that can also be used with R32

Tools/Materials	Use	Notes
Vacuum Pump with a Check Valve	Vacuum drying	
Bender	Bending pipes	
Torque Wrench	Tightening flare nuts	Only $\phi 12.70$ (1/2") and $\phi 15.88$ (5/8") have a larger flare machining dimension.
Pipe Cutter	Cutting pipes	
Welder and Nitrogen Cylinder	Welding pipes	
Refrigerant Charging Meter	Refrigerant charging	
Vacuum Gauge	Checking vacuum degree	

4. Tool and materials that must not used with R32

Tools/Materials	Use	Notes
Charging Cylinder	Refrigerant Charging	Must not be used with R32 -type units.

Tools for R32 must be handled with special care, and keep moisture and dust from entering the cycle.

# Read Before Installation

## Piping Materials

### Types of Copper Pipes (Reference)

Maximum Operation Pressure	Applicable Refrigerants
3.4MPa	R22, R407C
4.3 MPa	R32

- Use pipes that meet the local standards.

### Piping Materials/Radial Thickness

Use pipes made of phosphorus deoxidized copper.

Since the operation pressure of the units that use R32 is higher than that of the units for use with R22, use pipes with at least the radial thickness specified in the chart below. (Pipes with a radial thickness of 0.7mm or less may not be used.)

Size(mm)	Size(inch)	Radial Thickness(mm)	Type
φ 6.35	1/4"	0.8t	Type-O pipes
φ 9.52	3/8"	0.8t	
φ 12.7	1/2"	0.8t	
φ 15.88	5/8"	1.0t	
φ 19.05	3/4"	1.0t	Type-1/2H or Hpipes

- Although it was possible to use type-O for pipes with a size of up to φ 19.05(3/4") with conventional refrigerants, use type-1/2H pipes for units that use R32. (Type-O pipes may be used if the pipe size is φ19.05 and the radial thickness is 1.2t.)
- The table shows the standards in Japan. Using this table as a reference, choose pipes that meet the local standards.

### Flare Machining (type-O and OL only)

The flare machining dimensions for units that use R32 is larger than those for units that use R22 in order to increase air tightness.

#### Flare Machining Dimension(mm)

External dimension of pipes	Size	Dimension A	
		R32	R22
φ6.35	1/4"	9.1	9.0
φ9.52	3/8"	13.2	13.0
φ12.7	1/2"	16.6	16.2
φ15.88	5/8"	19.7	19.4
φ19.05	3/4"	24.0	23.3

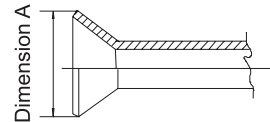

If a clutch type flare tool is used to machine flares on units that use R32, make the protruding part of the pipe between 1.0 and 1.5mm. Copper pipe gauge for adjusting the length of pipe protrusion is useful.

### Flare Nut

Type-2 flare nuts instead of type-1 nuts are used to increase the strength. The size of some of the flare nuts have also been changed.

#### Flare nut dimension(mm)

External dimension of pipes	Size	Dimension B	
		R32 (Type2)	R22(Type1)
φ6.35	1/4"	17.0	17.0
φ9.52	3/8"	22.0	22.0
φ12.7	1/2"	26.0	24.0
φ15.88	5/8"	29.0	27.0
φ19.05	3/4"	36.0	36.0

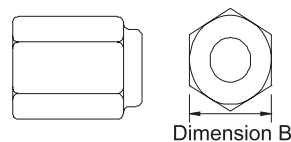

- The table shows the standards in Japan. Using this table as a reference, choose pipes that meet the local standards.

# Read Before Installation

## Air Tightness Test

No changes from the conventional method. Note that a refrigerant leakage detector for R22 or R410A cannot detect R32 leakage.

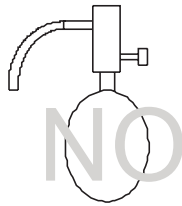

Halide torch

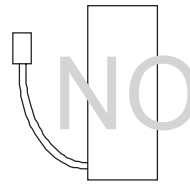

R22 or R407C leakage detector

### Items to be strictly observed :

1. Pressurize the equipment with nitrogen up to the design pressure and then judge the equipment's air tightness, taking temperature variations into account.
2. When investigating leakage locations using a refrigerant, be sure to use R32.
3. Ensure that R32 is in a liquid state when charging.

### Reasons:

1. Use of oxygen as the pressurized gas may cause an explosion.
2. Charging with R32 gas will lead the composition of the remaining refrigerant in the cylinder to change and then this refrigerant can not be used.

## Vacuumping

### 1. Vacuum pump with check valve

A vacuum pump with a check valve is required to prevent the vacuum pump oil from flowing back into the refrigerant circuit when the vacuum pump power is turned off (power failure). It is also possible to attach a check valve to the actual vacuum pump afterwards.

### 2. Standard degree of vacuum for the vacuum pump

Use a pump which reaches 65Pa or below after 5 minutes of operation.

In addition, be sure to use a vacuum pump that has been properly maintained and oiled using the specified oil. If the vacuum pump is not properly maintained, the degree of vacuum may be too low.

### 3. Required accuracy of the vacuum gauge

Use a vacuum gauge that can measure up to 650Pa. Do not use a general gauge manifold since it cannot measure a vacuum of 650Pa.

### 4. Evacuating time

Evacuate the equipment for 1 hour after 650Pa has been reached.

After envacuating, leave the equipment for 1 hour and make sure the that vacuum is not lost.

### 5. Operating procedure when the vacuum pump is stopped

In order to prevent a backflow of the vacuum pump oil, open the relief valve on the vacuum pump side or loosen the charge hose to drawn in air before stopping operation. The same operating procedure should be used when using a vacuum pump with a check valve.

## Charging Refrigerant

R32 must be in a liquid state when charging.

### Reasons:

R32 is a HFC refrigerant (boiling point =  $-52^{\circ}\text{C}$ ) and can roughly be handled in the same way as R410A; however, be sure to fill the refrigerant from the liquid side, for doing so from the gas side will somewhat change the composition of the refrigerant in the cylinder.

### Note

- In the case of a cylinder with a syphon, liquid R32 is charged without turning the cylinder up side down. Check the type of cylinder before charging.

### Remedies to be taken in case of a refrigerant leak

When refrigerant leaks, additional refrigerant may be charged. (Add the refrigerant from the liquid side)

## Characteristics of the Conventional and the New Refrigerants

- Because R32 is a simulated azeotropic refrigerant, it can be handled in almost the same manner as a single refrigerant such as R22. However, if the refrigerant is removed in the vapor phase, the composition of the refrigerant in the cylinder will somewhat change.
- Remove the refrigerant in the liquid phase. Additional refrigerant may be added in case of a refrigerant leak.

### 1. Accessories

"Edging" for protection of electrical wires from an opening edge.

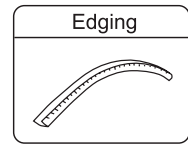

### 2. Selection of the place of installation

Select the place of installation satisfying the following conditions and, at the same time, obtain a consent from the client or user.

- Place where air circulates.
- Place free from heat radiation from other heat sources.
- Place where drain water may be discharged.
- Place where noise and hot air may not disturb the neighborhood.
- Place where there is not heavy snowfall in the winter time.
- Place where obstacles do not exist near the air inlet and air outlet .
- Place where the air outlet may not be exposed to a strong wind.
- Place surrounded at four sides are not suitable for installation. A 1m or more of overhead space is needed for the unit.
- Avoid mounting guide-louvers to the place where short-circuit is a possibility.
- When installing several units, secure sufficient suction space to avoid short circuiting.

### Open space requirement around the unit

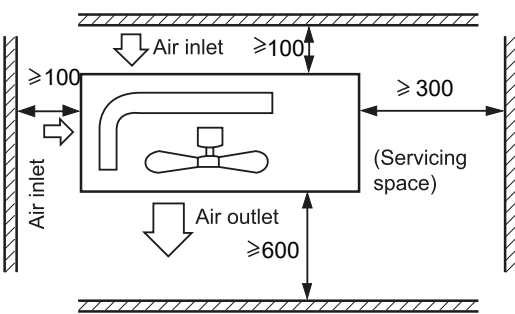

### Note :

- (1) Fix the parts with screws.
- (2) Don't intake the strong wind directly to the outlet air-flow hole.
- (3) A one meter distance should be kept from the unit top.
- (4) Don't block the surroundings of the unit with sundries.
- (5) If the outdoor unit is installed in a place that is exposed to the wind, install the unit so that the outlet grid is NOT pointing in the direction of the wind.

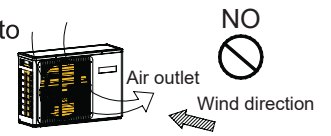

### 3. Installation of outdoor unit

Fix the unit on the foundation in a proper way according to the condition of the installation place, referring to the following information.

- Give enough room for the concrete foundation to fix by anchor bolts.
- Place the concrete foundation deep enough.
- Install the unit so that the angle of inclination must be less than 3 degrees.
- Forbidden to place the unit on the ground directly. Please confirm there is enough room near the drainage hole on bottom plate, which will ensure the water be drained smoothly.

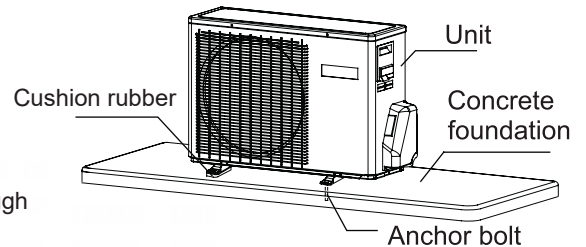

### 4. Installation dimension(Unit:mm)

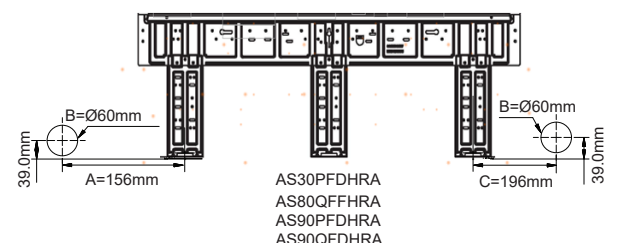
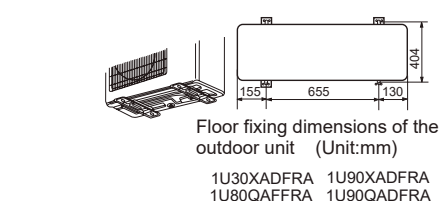
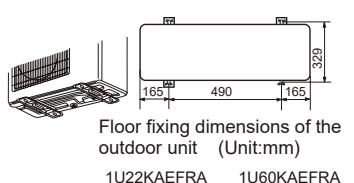
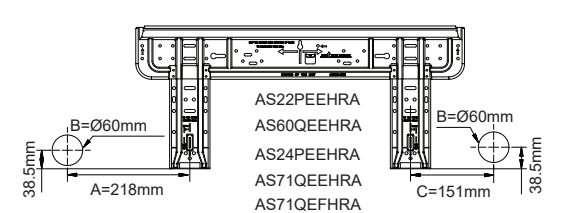
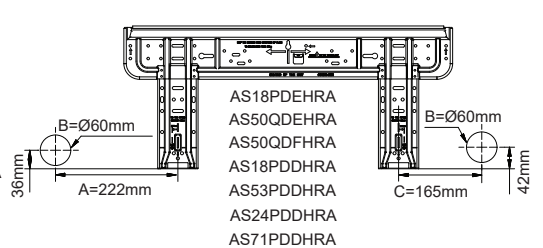
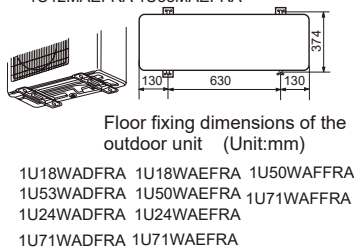
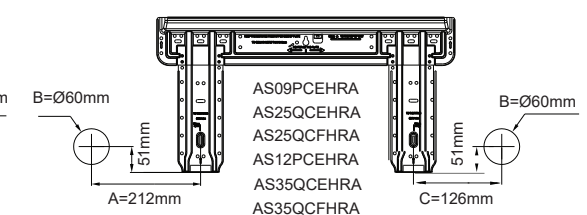
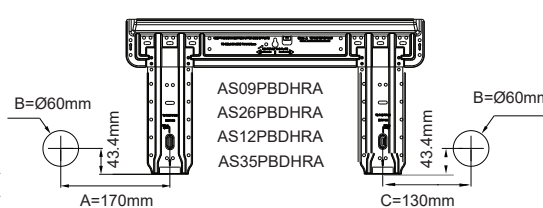
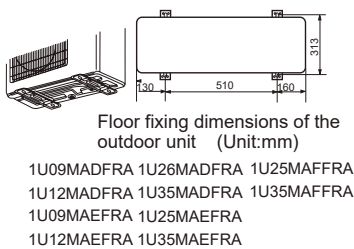

## 1. Piping size

FOR	AS26PBDHRA/1U26MADFRA AS35PBDHRA/1U35MADFRA AS25QCEHRA/1U25MAEFRA AS35QCEHRA/1U35MAEFRA AS25QCFHRA/1U25MAFFRA AS35QCFHRA/1U35MAFFRA	Liquid pipe	$\phi$ 6.35x0.8mm
		Gas pipe	$\phi$ 9.52x0.8mm
FOR	AS53PDDHRA/1U53WADFRA AS71PDDHRA/1U71WADFRA AS50QDEHRA/1U50WAEFRA AS50QDFHRA/1U50WAEFRA AS60QEEHRA/1U22KAEFRA AS71QEEHRA/1U71WAEFRA AS71QEFHRA/1U71WAEFRA	Liquid pipe	$\phi$ 6.35x0.8mm
		Gas pipe	$\phi$ 12.7x0.8mm
FOR	AS80QFFHRA/1U80QAFFRA AS90PFDHRA/1U90XADFRA AS90QFDHRA/1U90QADFRA	Liquid pipe	$\phi$ 6.35x0.8mm
		Gas pipe	$\phi$ 15.88x0.8mm

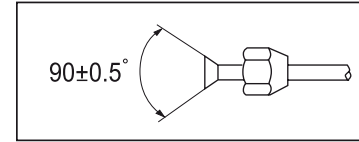

- Install the removed flare nuts to the pipes to be connected, then flare the pipes.

## 2. Connection of pipes

- When bending the pipe, avoid crushing it and prevent sharp bends to prevent breakage.
- Use a radius of curvature of 40 mm or more when bending the pipe.
- Start by connecting the gas side pipe first for easier work.
- Use specialized connection pipes designed for R32 refrigerant.

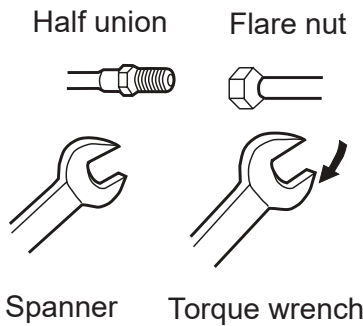

Forced fastening without proper centering can damage threads, resulting in gas leakage.

Pipe Diameter( $\phi$ )	Fastening torque
Liquid side 6.35mm(1/4")	18N.m
Liquid/Gas side 9.52mm(3/8")	42 N.m
Gas side 12.7mm(1/2")	55N.m
Gas side 15.88mm(5/8")	60 N.m

**Be cautious to prevent foreign matter such as sand, water, etc. from entering the pipe.**

### CAUTION:

The standard pipe length is C meters. If the pipe needs to be lengthened, refrigerant should be charged at a rate of D grams per meter. However, refrigerant charging must be performed by a professional air conditioner engineer. Before adding additional refrigerant, purge air from the refrigerant pipes and indoor unit using a vacuum pump, then charge the additional refrigerant.

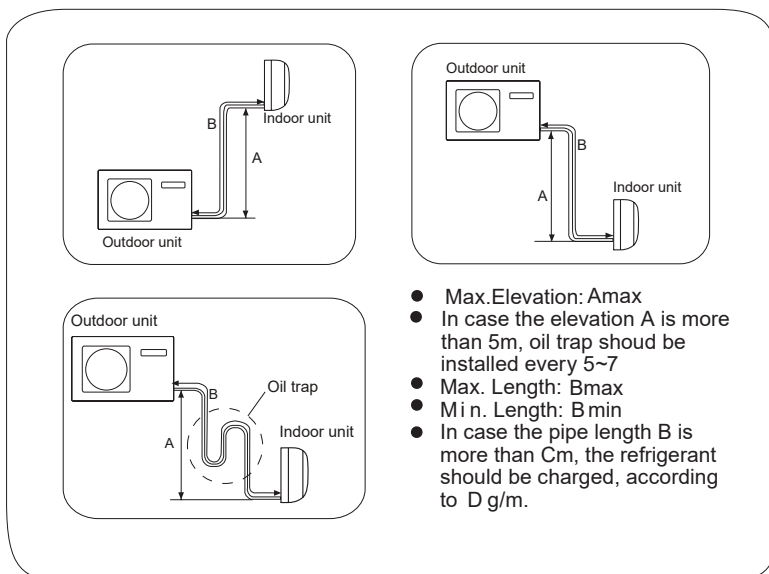

Outdoor Unit	Amax	Bmax	Bmin	C	D
1U26MADFRA 1U35MADFRA 1U25MAEFRA 1U35MAEFRA 1U25MAFFRA 1U35MAFFRA	10	15	3	7	20
1U53WADFRA 1U71WADFRA 1U50WAEFRA 1U50WAEFRA 1U60KAEFRA 1U71WAEFRA 1U71WAEFRA	15	25	3	10	20
1U80QAFFRA 1U90XADFRA 1U90QADFRA	15	25	3	10	50

After completing the connection of the refrigerant pipe, an air tightness test should be conducted.

- Use a nitrogen tank to pressurize according to the pipe connection mode as shown in the diagram.
- Ensure that both the gas and liquid valves are closed. Before pressurizing to prevent nitrogen from entering the outdoor unit's circulation system, tighten the valve rods (both gas and liquid valve rods).

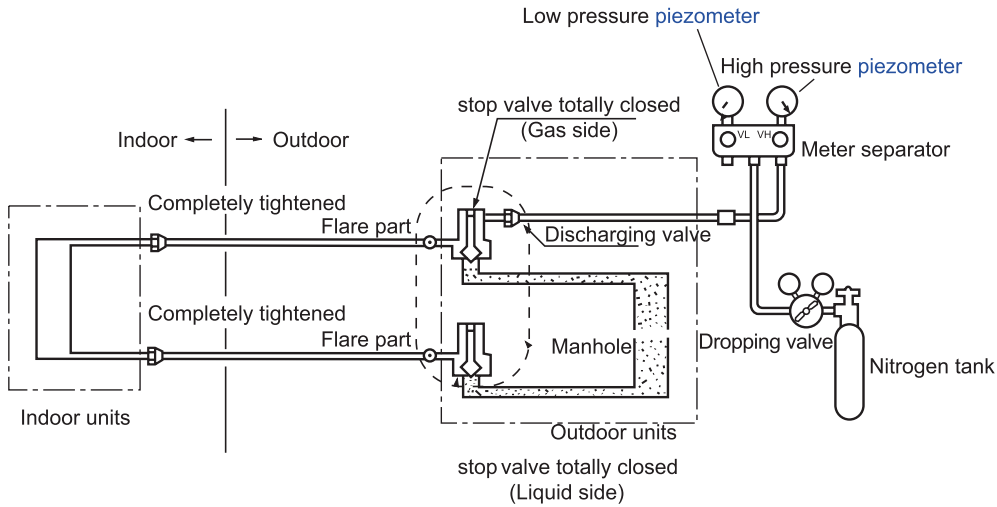

- 1) Pressurize for over 3 minutes at 0.3 MPa (3.0 kg/cm<sup>2</sup>g).
- 2) Pressurize for over 3 minutes at 1.5 MPa (15 kg/cm<sup>2</sup>g). Large leakage will be detected.
- 3) Pressurize for about 24 hours at 3.0 MPa (30 kg/cm<sup>2</sup>g). Small leakage will be detected.

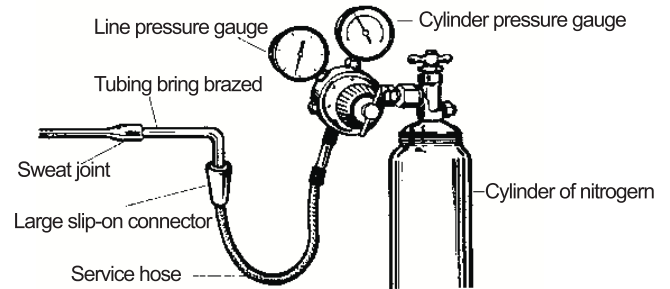

- Tubing is brazed.
- Check if the pressure drops using the service hose.
  - If pressure remains stable, pass.
  - If pressure drops, check for the leaking point.
  - During the 24-hour pressure test, a 1°C variation in ambient temperature will cause a 0.01 MPa (0.1 kg/cm<sup>2</sup>g) pressure variation, which should be corrected during the test.
- Checking for leaks:
  - In steps 1 to 3, if pressure drops, check for leaks at each joint by listening, touching, and using soap water. After identifying the leak, re-weld or tighten the nut securely.



### Piping vavuum method: to use vacuum pump

1. Detach the service port's cap of 3-way valve, the valve rod's cap for 2-way valve and 3-way valves, and connect the service port into the projection of charge hose (low) for gaugemanifold. Then connect the projection of charge hose (center) for gaugemanifold into vacuum pump.

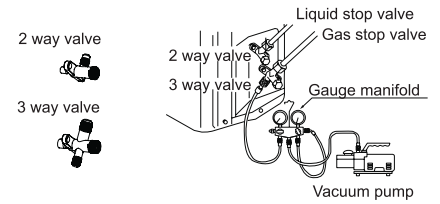

2. Open the low-pressure handle on the gauge manifold. Start the vacuum pump. If the gauge needle on the low-pressure side quickly moves to indicate a vacuum condition, double-check step 1.

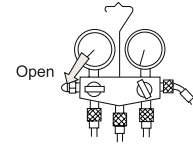

3. Vacuumise the system for over 15 minutes. Check the level gauge, which should read approximately -0.1 MPa (-76 cm Hg) on the low-pressure side. Once vacuuming is complete, close the "Lo" handle on the vacuum pump. Check the gauge's condition and hold it for 1-2 minutes. If the gauge needle moves back despite tightening, redo the flaring work, then repeat step 3 from the beginning.

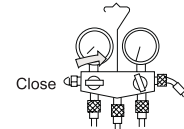

4. Open the valve for the 2-way valve to an angle of anticlockwise 90 degree. After 6 seconds, close the 2-way valve and make the inspection of gas leakage.

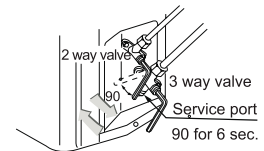

5. If there is no gas leakage, proceed to the next step. In the event of gas leakage, tighten the pipe connection parts. If the leakage stops, continue to step 6. If the leakage persists despite tightening, release all refrigerants from the service port. After redoing the flaring work, refill the prescribed refrigerant from the gas cylinder.

6. Detach the charge hose from the service port, then open both the 2-way valve and the 3-way valve. Turn the valve rod anticlockwise until it lightly hits.

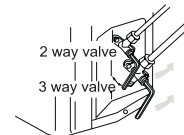

7. To prevent gas leakage, tighten the service ports cap, the valve rod's cap for the 2-way valve, and the 3-way's slightly beyond the point where the torque suddenly increases.

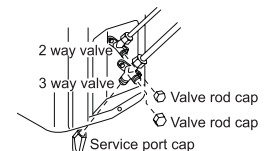

### CAUTION:

If there's a refrigerant leak in the air conditioner, it's necessary to remove all the refrigerant. First, evacuate the remaining liquid refrigerant from the air conditioner according to the amount specified on the nameplate.

**WARNING!**

**DANGER OF BODILY INJURY OR DEATH**

- TURN OFF ELECTRIC POWER AT CIRCUIT BREAKER OR POWER SOURCE BEFORE MAKING ANY ELECTRIC CONNECTIONS.
- GROUND CONNECTIONS MUST BE COMPLETED BEFORE MAKING LINE VOLTAGE CONNECTIONS.

**Precautions for Electrical wiring**

- Electrical wiring work should be conducted only by authorized personnel.
- Do not connect more than three wires to the terminal block. Always use round type crimped terminal lugs with insulated grip on the ends of the wires.
- Use copper conductor only.

**Selection of size of power supply and interconnecting wires**

Select wire sizes and circuit protection from table below. (This table shows 20 m length wires with less than 2% voltage drop.)

Item Model	Phase	Circuit breaker		Power source wire size (minimum) (mm <sup>2</sup> )	Earth leakage breaker	
		Switch breaker (A)	Overcurrent protector rated capacity (A)		Switch breaker(A)	Leak current(mA)
1U26MADFRA 1U35MADFRA	1	20	15	2.5	20	30
1U25MAEFRA 1U35MAEFRA 1U25MAFFRA 1U35MAFFRA	1	25	15	2.5	20	30
1U53WADFRA 1U50WAEFRA 1U50WAFFRA 1U60KAEFRA 1U71WAEFRA 1U71WAFFRA	1	25	20	2.5	25	30
1U71WADFRA	1	25	30	2.5	25	30
1U80QAFFRA	1	30	30	4.0	25	30
1U90XADFRA 1U90QADFRA	1	30	30	4.0	25	30

- If the supply cord is damaged, it must be replaced by the manufacturer or its service agent or a similar qualified person.
- If the fuse of control box is broken, please change it with the ceramic type of AC 250V, T30A.
- The wiring method should be in line with the local wiring standard.
- All the cables shall have got the local authentication certificate. During installation, when the connecting cables break off, it must be assured that the grounding wire is the last one to be broken off.
- The explosion-proof breaker of the air conditioner should be all-pole switch. The distance between its two contacts should not be no less than 3mm. Such means for disconnection must be incorporation in the fixed wiring.
- The distance between its two terminal blocks of indoor unit and outdoor unit should not be over 5m. If exceeded, the diameter of the wire should be enlarged according to the local wiring standard.
- A explosion-proof breaker must be installed.

**Wiring procedure**

- 1) Remove set screws on the side before taking off the front panel toward the direction.
- 2) Connect wires to the terminal block correctly and fix the wires with a wire clamp equipped nearby the terminal block.
- 3) Route the wires in a proper way and penetrate the wires through the opening for electrical wiring on the side panel.

**WARNING:**

*INTERCONNECTING WIRES MUST BE WIRED ACCORDING TO FIGURE BELOW. INCORRECT WIRING MAY CAUSE EQUIPMENT DAMAGE.*

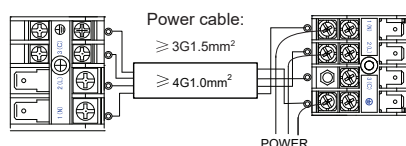

1U26MADFRA 1U25MAEFRA 1U25MAFFRA  
1U35MADFRA 1U35MAEFRA 1U35MAFFRA

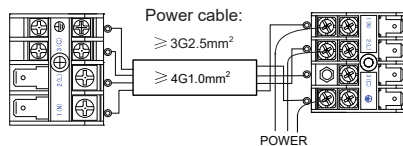

1U60KAEFRA

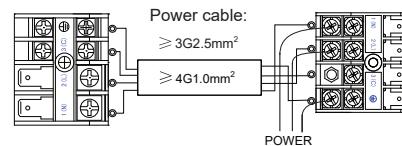

1U53WADFRA 1U50WAEFRA 1U50WAFFRA  
1U71WADFRA 1U71WAEFRA 1U71WAFFRA

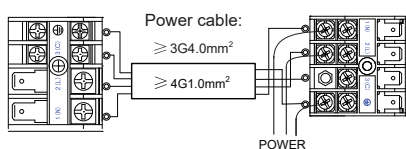

1U80QAFFRA  
1U90XADFRA  
1U90QADFRA

Model	2.5/2.6KW	3.5KW	5.0/5.3KW	6.0KW	7.1KW	9.0KW
Connecting wiring	4G1.0mm <sup>2</sup>	4G1.0mm <sup>2</sup>	4G1.0mm <sup>2</sup>	4G1.0mm <sup>2</sup>	4G1.0mm <sup>2</sup>	4G1.0mm <sup>2</sup>
Power cable	3G1.5mm <sup>2</sup>	3G1.5mm <sup>2</sup>	3G2.5mm <sup>2</sup>	3G2.5mm <sup>2</sup>	3G2.5mm <sup>2</sup>	3G4.0mm <sup>2</sup>

# Outdoor Unit Troubleshooting

## CAUTION!

- THIS UNIT WILL START IMMEDIATELY ONCE ELECTRIC POWER IS SUPPLIED, WITHOUT REQUIRING AN "ON" OPERATION. ENSURE TO PERFORM AN "OFF" OPERATION BEFORE DISCONNECTING ELECTRIC POWER FOR SERVICING.
- This unit has a function of automatic restart system after recovering power stoppage.

### 1. Before starting test run (for all Heat pump models)

Before conducting a test run for all heat pump models, ensure that the power source breaker (main switch) of the unit has been turned on for over 12 hours to energize the crankcase heater in advance of operation.

### 2. Test run

During the initial 30-minute run, carefully monitor the following parameters:

- Suction pressure at the check joint of the service valve for the gas pipe.
- Discharge pressure at the check joint on the compressor discharge pipe.
- Temperature difference between the return air and supply air for the indoor unit.

	Code indication			fault description
	Indoor displaying panel code indication		Outdoor (LED1 flash times)	
Indoor and Outdoor	E7	Directly display	15	Communication fault between indoor and outdoor units
Indoor Malfunction	E1	Directly display	/	Indoor temperature sensor failure
	E2	Directly display	/	Indoor coil sensor failure
	E4	Directly display	/	Indoor eeprom failure
	E14	Directly display	/	Indoor fan failure
Outdoor Malfunction	E5	Trouble record	22	Internal unit antifreeze protection
	E9	Trouble record	21	Internal unit overload
	F12	Directly display	1	Eeprom failure
	F1	Directly display	2	IPM failure
	F22	Directly display	3	AC current overcurrent protection
	F3	Directly display	4	Communication error between module board and main PCB board.
	F20	Trouble record	5	High pressure protection
	F19	Trouble record	6	Power over/under voltage protection
	F27	Directly display	7	Compressor stall / press instantaneous stop
	F4	Directly display	8	Compressor discharging temperature protection
	F8	Trouble record	9	Abnormal of DC motor
	F21	Directly display	10	Abnormal of piping sensor
	F7	Directly display	11	Suction temperature sensor failure
	F6	Directly display	12	Abnormal of outdoor ambient sensor
	F25	Directly display	13	Abnormal of compressor discharge sensor
	F13	Trouble record	16	Lack of refrigerant
	F14	Trouble record	17	4-way valve reverse failure
	F11	Directly display	18	Compressor jam (only for spdu)
	F28	Directly display	19	Module PWM select circuit error
	F15	Trouble record	20	Outdoor terminal block temperature protection
	F2	Trouble record	24	Instantaneous over-current protection of the compressor
	F23	Trouble record	25	Compressor U-phase overcurrent Compressor V-phase overcurrent Compressor W-phase overcurrent
	F9	Trouble record	26	Module reset
F24	Trouble record	27	CT disconnection	
F34	Trouble record	37	Outdoor coil protection	
F35	Trouble record	38	Compressor driver board failure	
F43	/	46	Model matching abnormality	

## Customer Care

Visit the website for more information

Australia: [haierhome.com.au](http://haierhome.com.au)

New Zealand: [haierhome.co.nz](http://haierhome.co.nz)

Customer support and service booking

Australia: 1300 729 948

New Zealand: 0800 424 372

Important notice of Disclosure: Copyright © Fisher & Paykel Appliances 2024. All rights reserved.  
The product dimensions and specifications in this document apply to the specific products and models described at the date of issue. Under our policy of continuous product improvement, these dimensions and specifications may change at any time. You should therefore check with your dealer or Haier's Customer Care Centre to ensure this flyer correctly describes the products currently available.

Fisher & Paykel Appliances Australia Level 1, 1 Eden Park Drive, Macquarie Park, NSW 2113.  
New Zealand: Fisher & Paykel Appliances Ltd, 78 Springs Road, East Tamaki, Auckland 2013.

# Haier